

# UNITED STATES PUBLIC LAND SURVEY CORNER CERTIFICATE

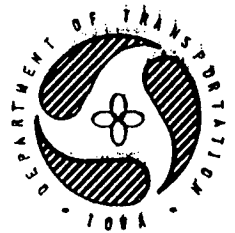

Section 12 Township 76 Range 28W County Madison

Certificate Prepared For: Grading and Resurfacing Project  
F-169-3(30)--20-61

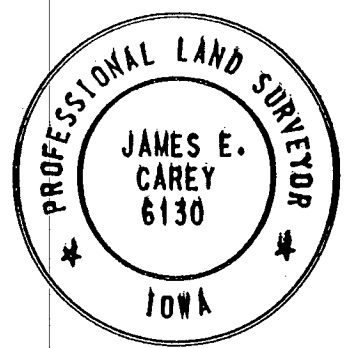
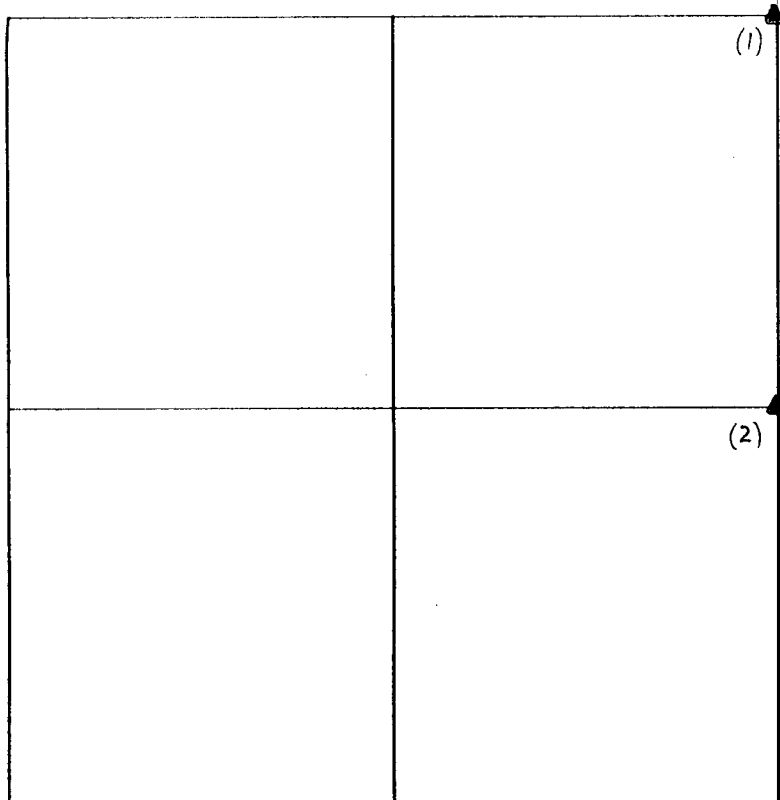

I hereby certify that this plat is a true and accurate representation of the land herein described, made by me or under my direct supervision, and that I am a duly registered Land Surveyor under the laws of the State of Iowa.

*James E. Carey* 7-9-92  
 James E. Carey Reg. No. 6130 Date

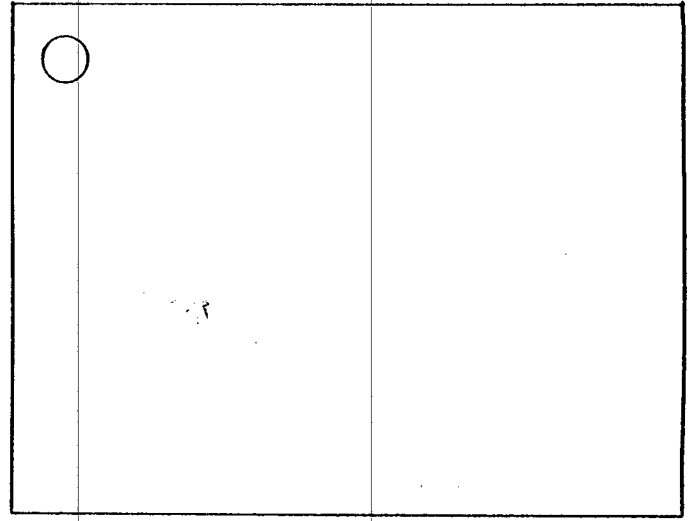
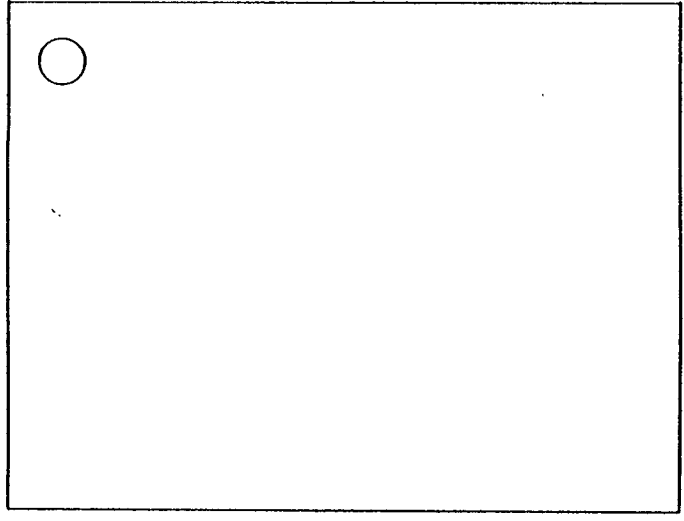
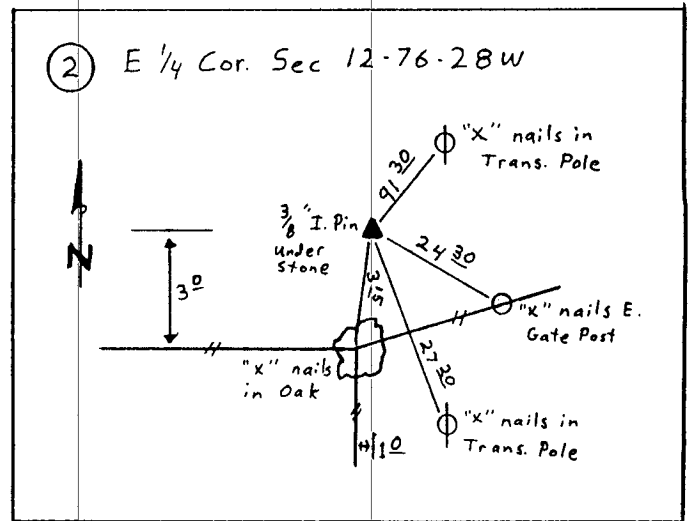
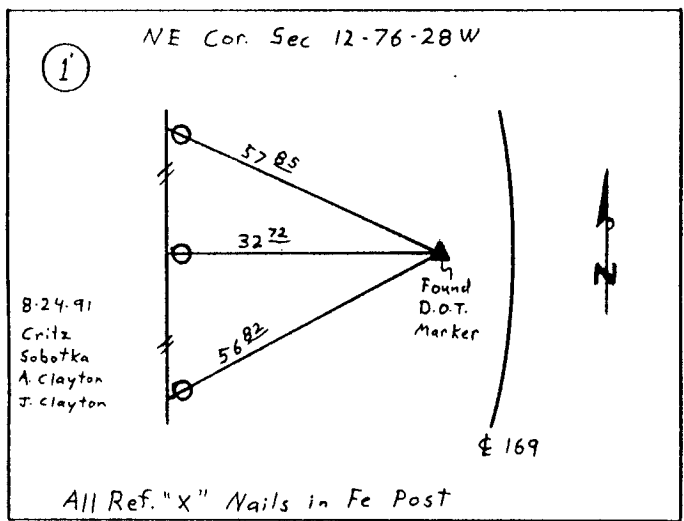

Recording Data: **91**  
 FILED NO. **91**  
 BOOK 1 PAGE 99  
 92 JUL 13 AM 11:16  
 MICHELLE UTSLER  
 RECORDER  
 MADISON COUNTY, IOWA  
 Fee \$5.00

IND.   
 REC.   
 PAGE

List Corner to be Indexed			
Corners	Section	Twp	Range
NE	12	76	28 W
E 1/4	12	76	28 W